



# Modelling cross flow microfiltration:

## alternative process design for the concentration and fractionation of suspensions

Ivon Drijer<sup>1,2</sup>, Ahmad Harbiye<sup>2</sup> and Karin Schroën<sup>1</sup>

<sup>1</sup> Laboratory of Food Process Engineering, Wageningen University and Research Centre, the Netherlands

<sup>2</sup> Veco B.V., the Netherlands

### Introduction

- Membrane microfiltration is used for the concentration and fractionation of components in different fields, a.o. the food and biotechnology industry<sup>3</sup>.
- In this study we focus on particles in the size range of 0.1 to 10  $\mu\text{m}$ .

Microfiltration processes, as currently applied, require a high amount of energy and suffer from fouling (figure 1)<sup>4</sup>.

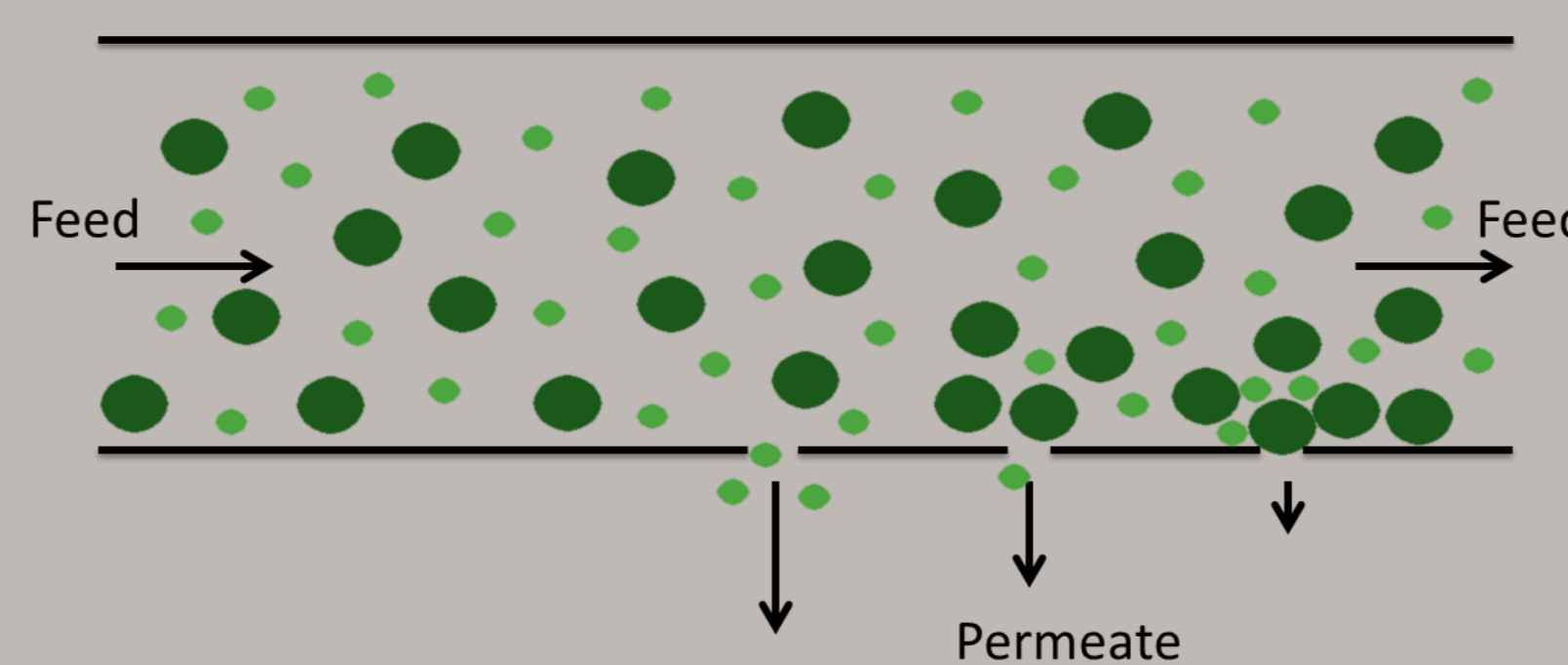

Figure 1: Schematic view on microfiltration as currently applied.

By making use of shear induced diffusion (SID) particle separation may already take place inside the channel (figure 2)<sup>4,5</sup>.

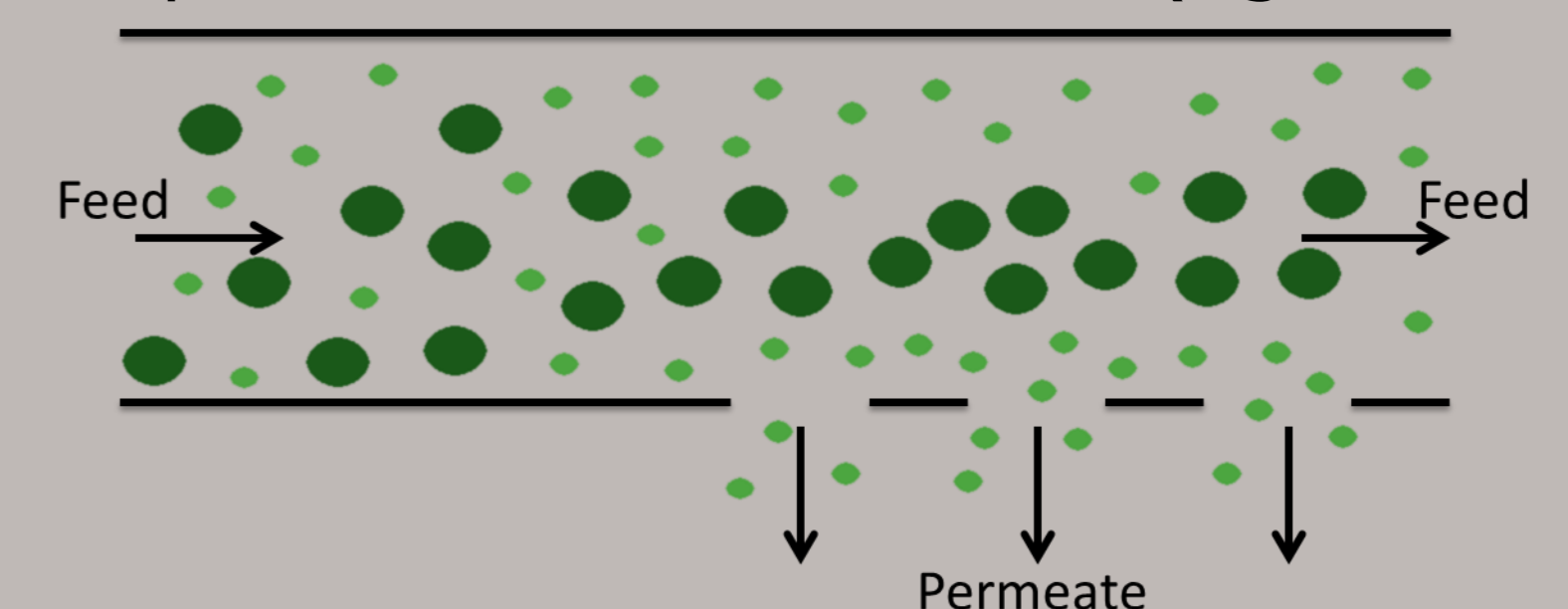

Figure 2: Schematic drawing of fractionation due to SID

Benefits<sup>4,5</sup>:

- Low energy input
  - Reduced fouling chances
  - Constant permeate flux
- Please note: Size ratio pore/particle > 1

### Current work

Starting point, modelling a monodisperse suspension in a closed channel for which a rectangular grid is used (figure 3).

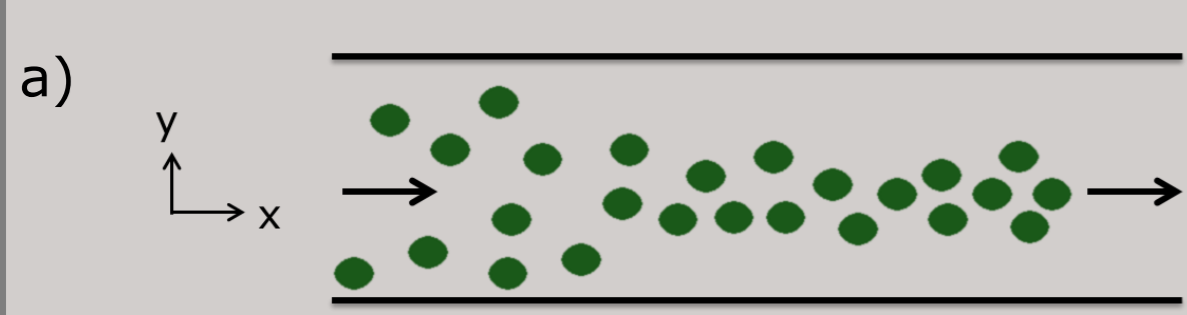
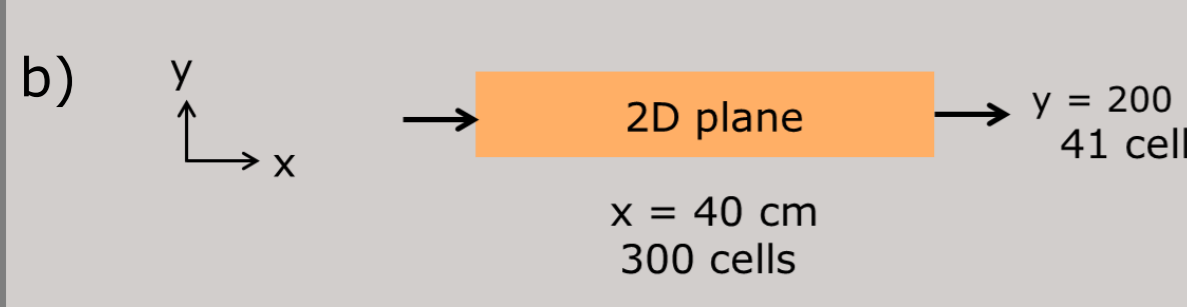

Figure 3: a) Schematic view of a monodisperse suspension in a closed channel,



b) Dimensions of the 2D channel and number of grid cells used for the simulation

Model:

- STAR-CCM+ from CD-adapco
- Euler-Euler model
- 2D simulation
- Momentum term for SID (based on Vollebregt et al. 2010<sup>6</sup>)

Expectations:

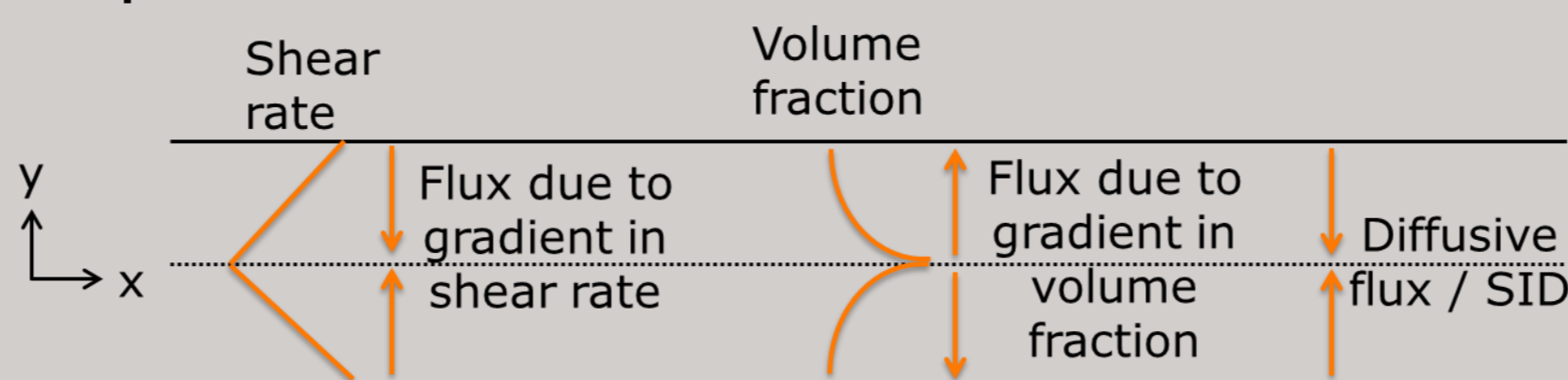

$$\text{Diffusive flux} = \text{flux due to } \nabla \text{ shear rate} + \text{flux due to } \nabla \text{ volume fraction}^6$$

Figure 4: Expectations of the model with regard to SID

Results:

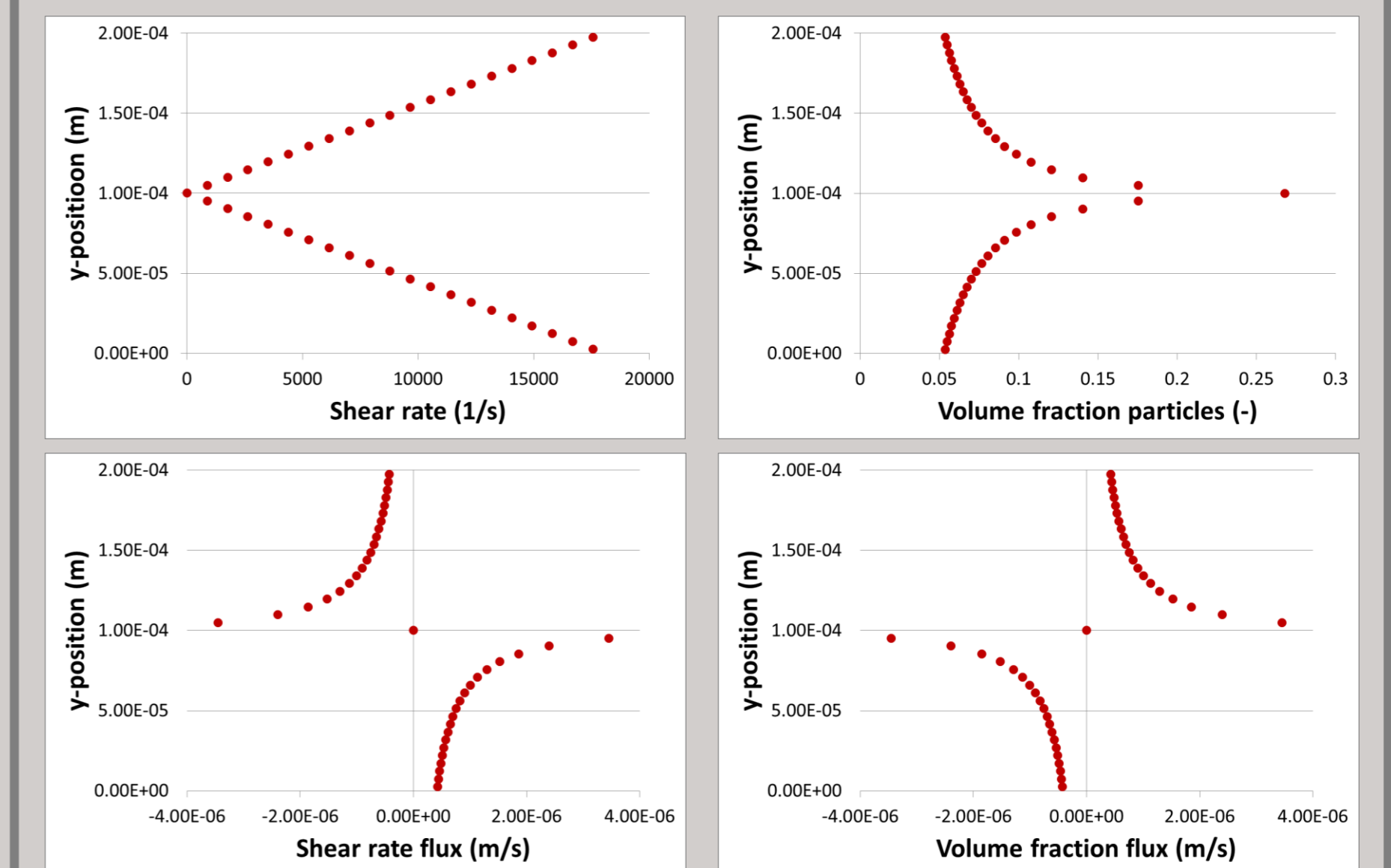

Figure 5: The position in the channel versus the shear rate (top left), the volume fraction (top right), the flux due to shear rate gradient (bottom left) and the flux due to the volume fraction gradient (bottom right)

### Future work

Experimental validation

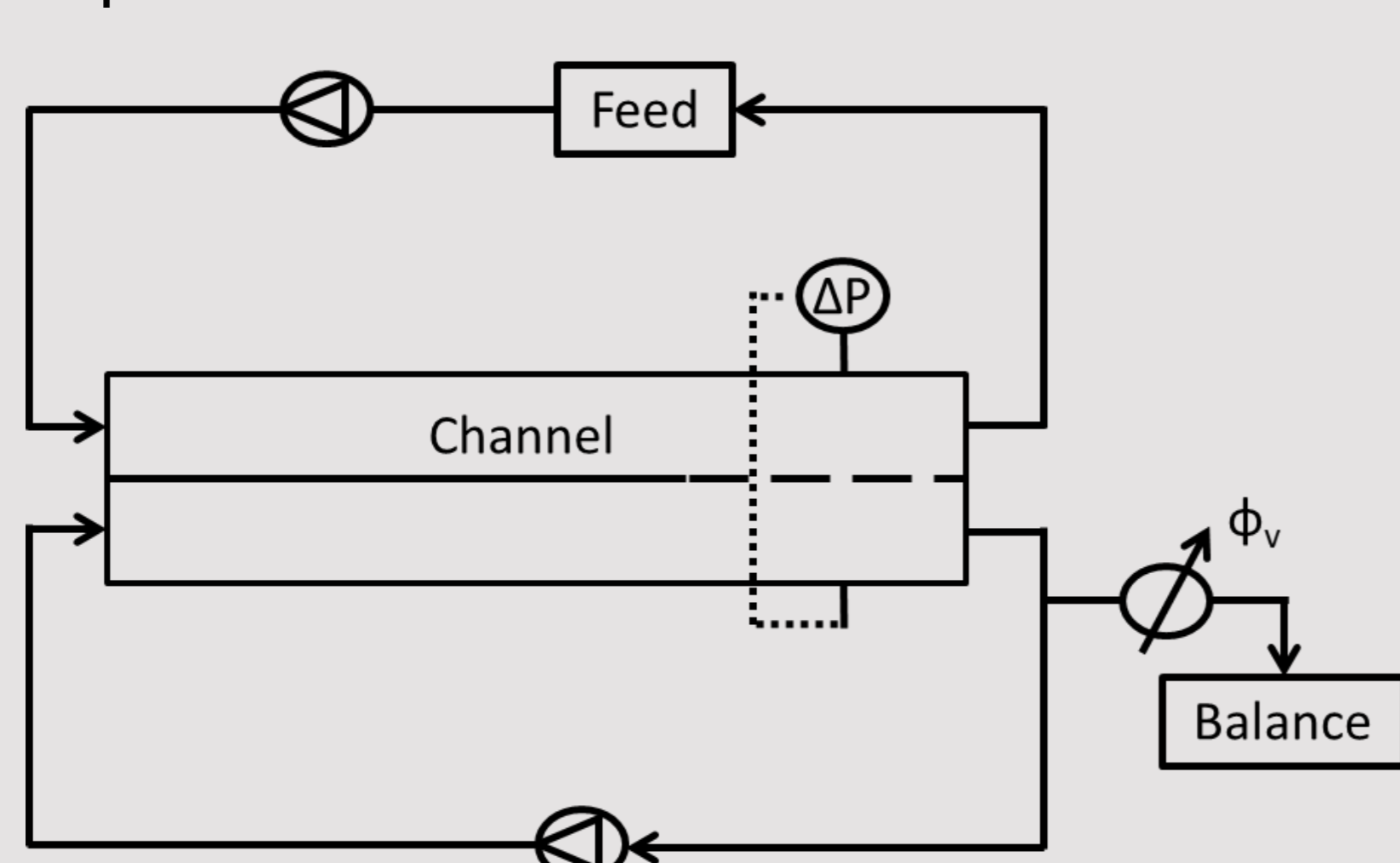
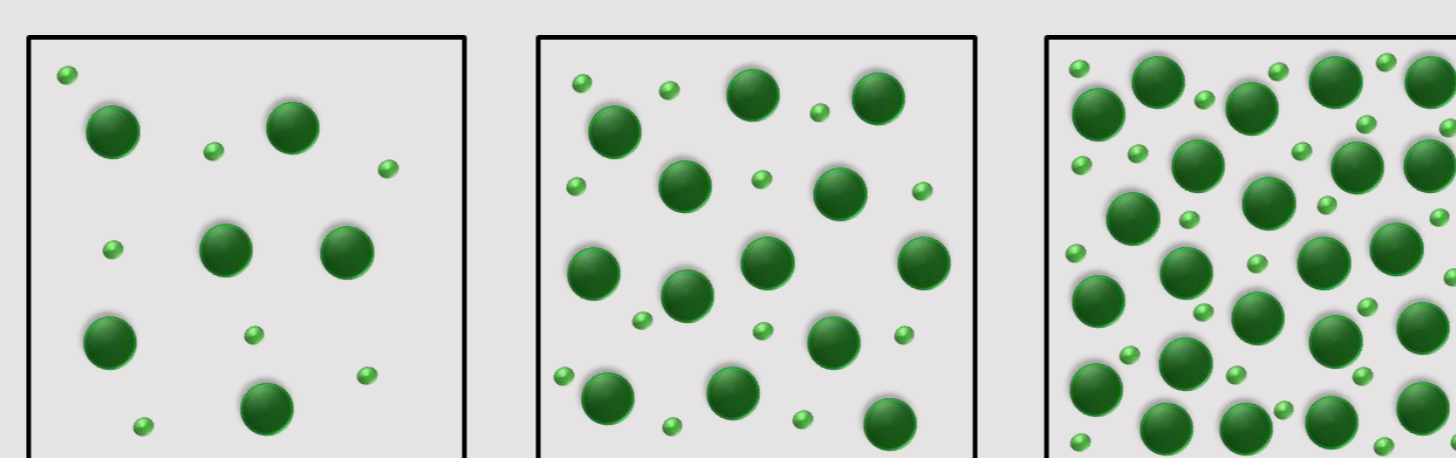
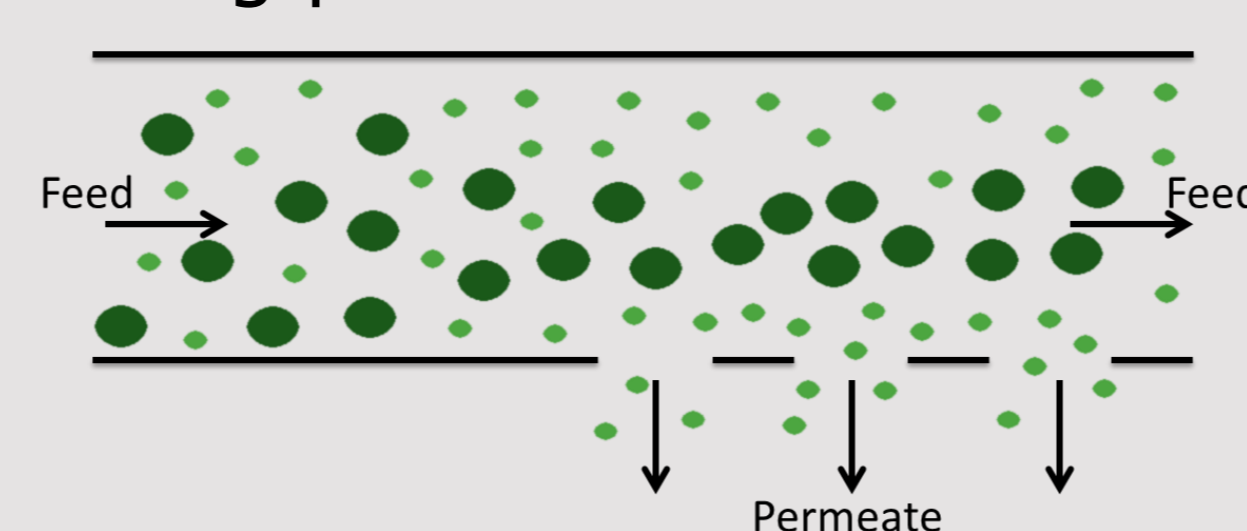

Figure 6: Schematic drawing of the experimental set up that will be used for validation.

Modelling different volume fractions and bidisperse suspensions



Modelling porous channels



Modelling the effect of membrane design

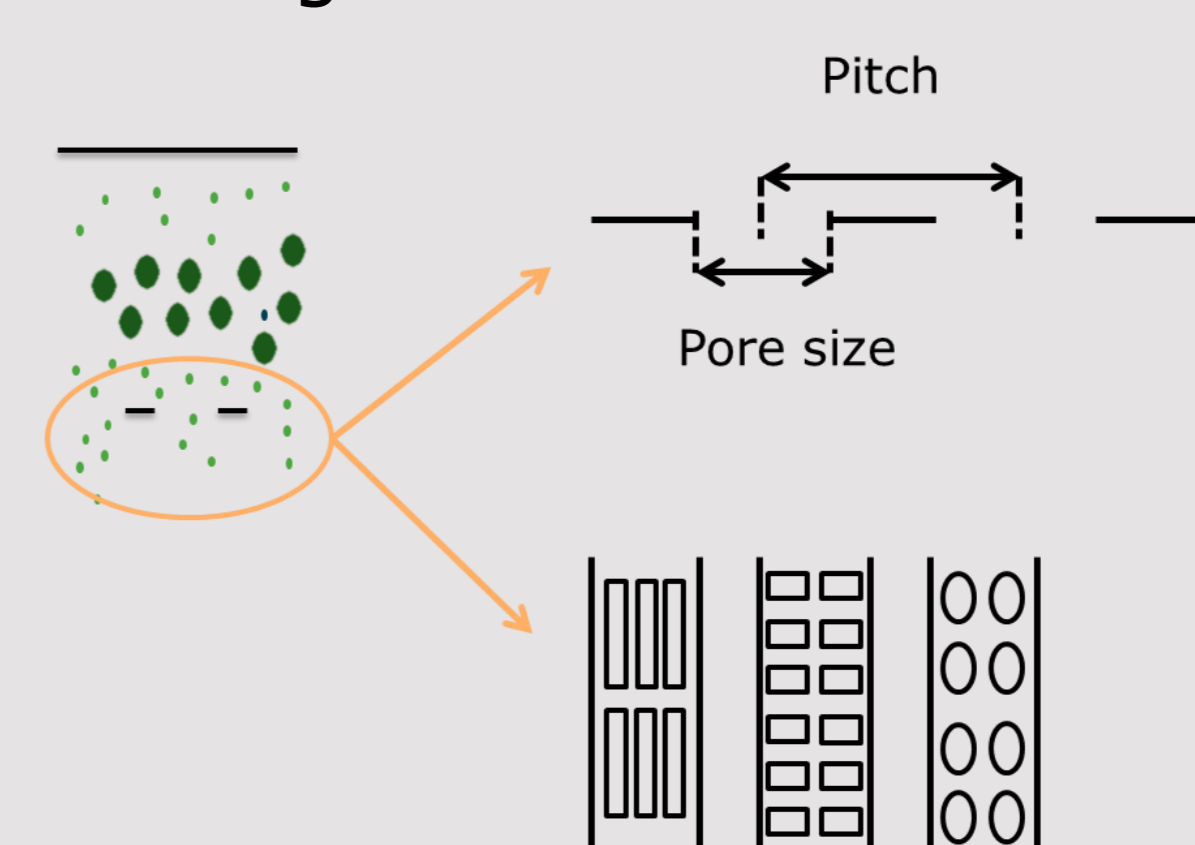

Modelling differences in particle shape

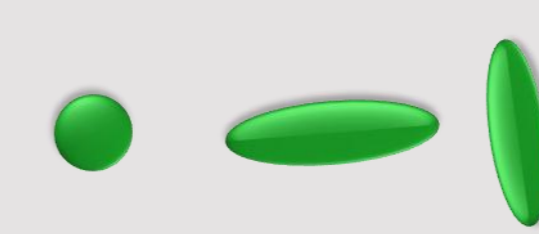

### Acknowledgement and references

3. H. Strathmann, 2001, 'Membrane Separation Processes: Current Relevance and Future Opportunities', *AIChE Journal*, 47 (5), 1077-1087
4. A.M.C. van Dinther, C.G.P.H. Schroën, and R.M. Boom, 'Separation Process for Very Concentrated Emulsions and Suspensions in the Food Industry', *Innovative Food Science & Emerging Technologies*, 18, 177-182.
5. A.M.C. van Dinther, C.G.P.H. Schroën, and R.M. Boom, 2013, 'Particle Migration Leads to Deposition-Free Fractionation', *Journal of Membrane Science*, 440, 58-66.
6. H.M. Vollebregt, R.G.M. van der Sman, and R.M. Boom, 2010, 'Suspension flow modelling in particle migration and microfiltration', *Soft matter*, 6, 6052-6064.

This work is supported by NanoNextNL, a micro and nanotechnology consortium of the Government of the Netherlands and 130 partners.

